



ABS Solar Guard

für ABS Base Green



MoA 347 02



DIN EN
13374
2019-A

Werkzeuge | Tools

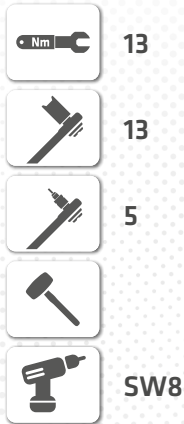

Sicherheitshinweise | Safety instructions



- DE** Montageanleitung beachten (1) und Sicherheitshinweise beachten (2).
- EN** Comply with the installation manual (1) and Comply with the safety instructions (2).
- FR** Respecter la notice de montage (1) and Respecter les consignes de sécurité (2).
- NL** Montagehandleiding in acht nemen (1) and Veiligheidsinstructies in acht nemen (2).
- BGR** Спазвайте инструкциите за монтаж (1) and Спазвайте инструкциите за безопасност (2).
- DK** Følg monteringsvejledningen (1) and Følg sikkerhedshenvisningerne (2).
- ET** Järgige paigaldusjuhendit (1) ja ohutusjuhiseid (2).
- FI** Noudata asennusohjeita (1) and Noudata turvallisuusohjeita (2).
- IT** Rispettare le istruzioni di montaggio (1) and Rispettare le istruzioni di sicurezza (2).
- PL** Przestrzegać zaleceń instrukcji montażu (1) and Przestrzegać zasad bezpieczeństwa (2).
- SK** Dodržujte návod na montáž (1) and Dodržujte bezpečnostné pokyny (2).
- SL** Sledite navodilom za namestitve (1) and Sledite varnostnim navodilom (2).
- ES** Observar las instrucciones de montaje (1) and Observar las indicaciones de seguridad (2).
- CS** Dodržujte návod k montáži (1) and Dodržujte bezpečnostní pokyny (2).
- HU** Vegye figyelembe az összeszerelési útmutatót (1) and Vegye figyelembe a biztonsági utasításokat (2).

Für eine ordnungsgemäße Montage ist eine Dokumentation des Einbaus zwingend erforderlich!
For a proper installation, a complete documentation of assembly is absolutely necessary.

Kontakte | Contact persons

Vertrieb & Technische Beratung
Sales & Technical Support
+49 (0) 28 32 - 972 81 - 0
vertrieb@absturzsicherung.de

Schulung
Training
+49 (0) 28 32 - 972 81 - 148
schulung@absturzsicherung.de

Montagevorbereitung
Assembly
+49 (0) 28 32 - 972 81 - 260
service@absturzsicherung.de

Mustertypenschild | Sample label

[ABS]

ABS SAFETY GMBH 3

Kevelaer, Germany
info@absturzsicherung.de
www.absturzsicherung.de

1
2

Mustertypenschild /
Sample only

Chargennummer /
Batch number

6	Normen / Standards	<input type="checkbox"/>	-
7	Max. Nutzer gleichzeitig (DIN EN 795:2012) Max. No. of simultaneous users	<input type="checkbox"/>	-
11	Modellnummer / Model number	<input type="checkbox"/>	-
<input type="checkbox"/>	-	<input type="checkbox"/>	-
<input type="checkbox"/>	-	<input type="checkbox"/>	-
<input type="checkbox"/>	-	<input type="checkbox"/>	-

CE

0158

U

Z-14.9-668

9

2004

10

DEKRA

PV-System Symbolerläuterung | Explanation of PV system symbols

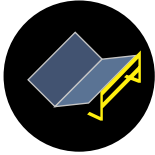

Längsseite-Montage /
Longitudinal installation

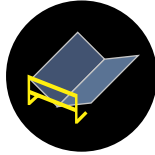

Querseite-Montage /
Transverse installation

Inhalt | Content



08



10



12



14



14



15



16



ABS Doku

Montageschritte dokumentieren

Document assembly step



Dokumentation mit Bildern vervollständigen!
Complete your documentation using pictures!

**Dokumentation
ist Pflicht!**

Documentation is compulsory!

absturzschutz.de/doku

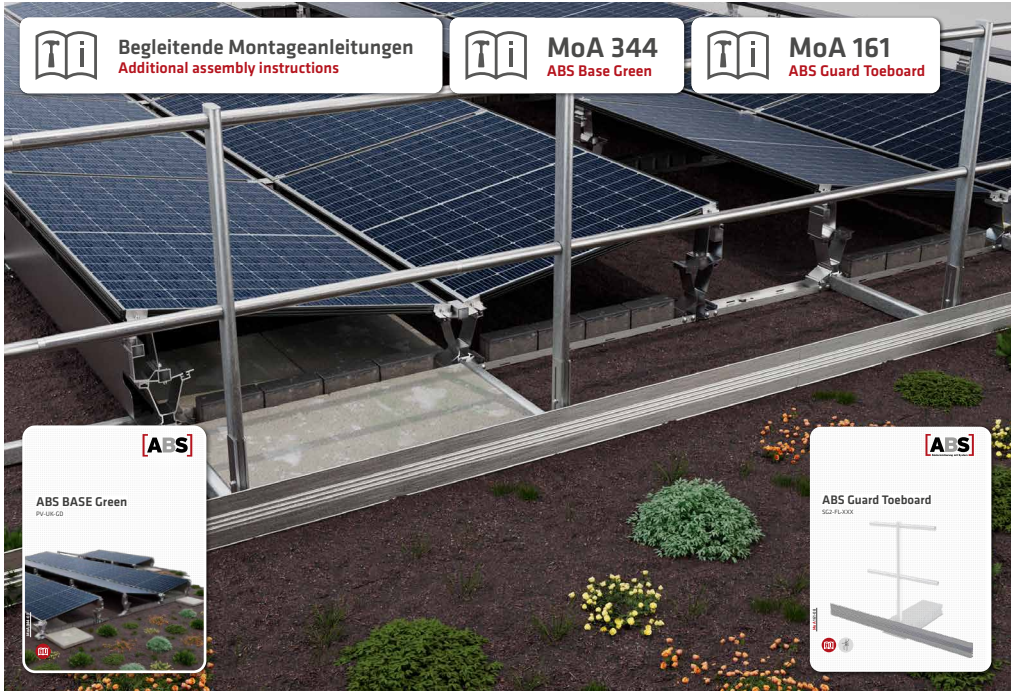

Begleitende Montageanleitungen
Additional assembly instructions



MoA 344
ABS Base Green



MoA 161
ABS Guard Toeboard

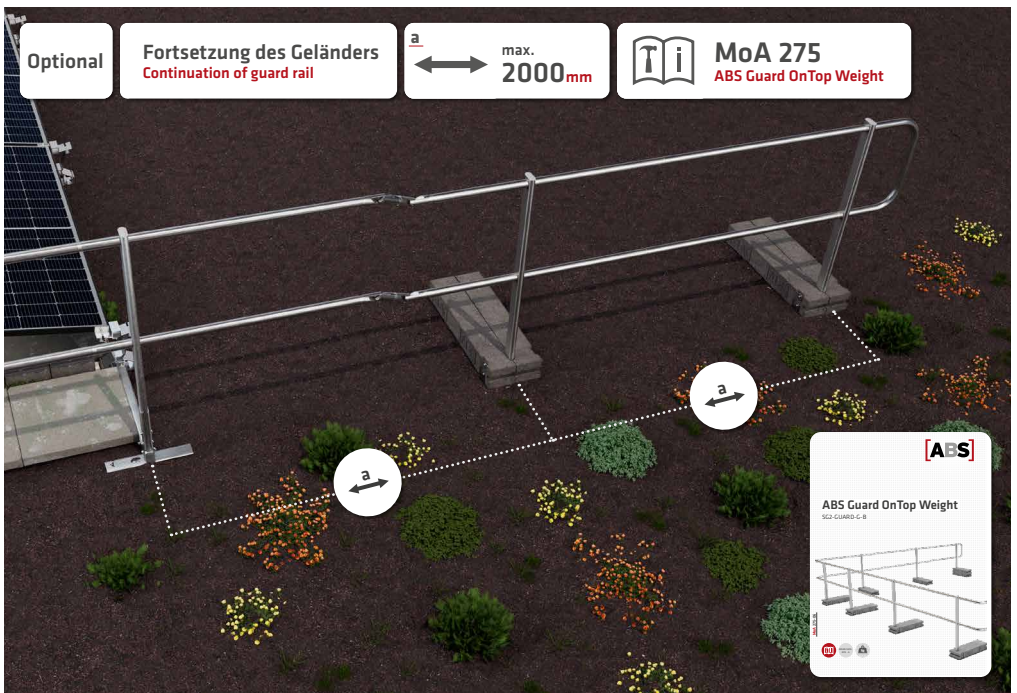

Optional

Fortsetzung des Geländers
Continuation of guard rail



MoA 275
ABS Guard OnTop Weight

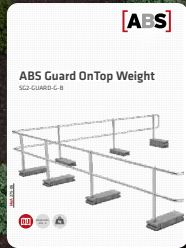



Notwendige Ballastierung Required ballasting



Weiter nach Ballastierungsplan
Continue according to the ballasting plan

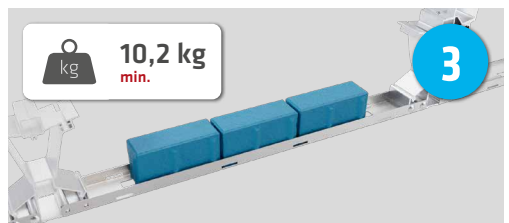
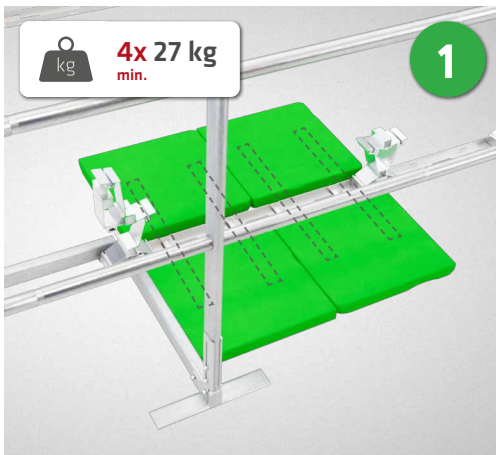
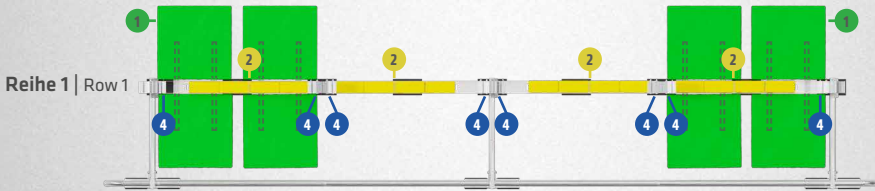
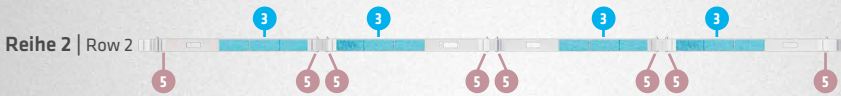

  **Notwendige Ballastierung**
Required ballasting

Weiter nach Ballastierungsplan
Continue according to the ballasting plan

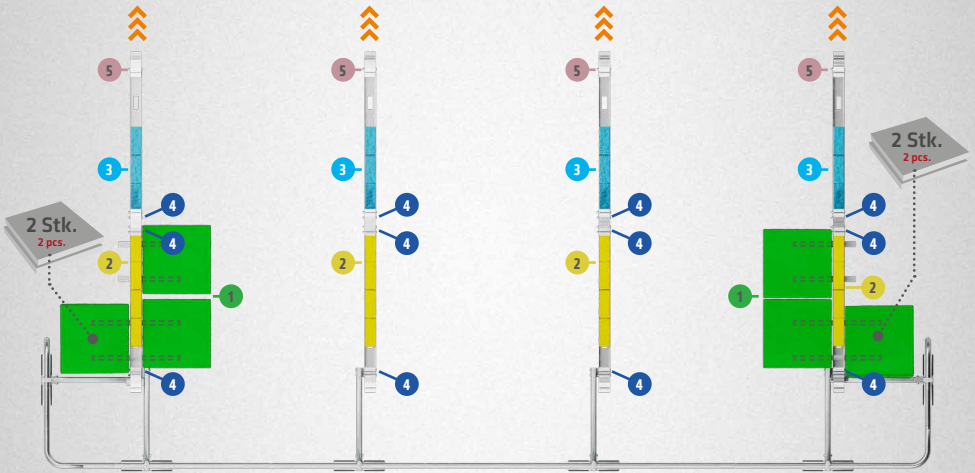

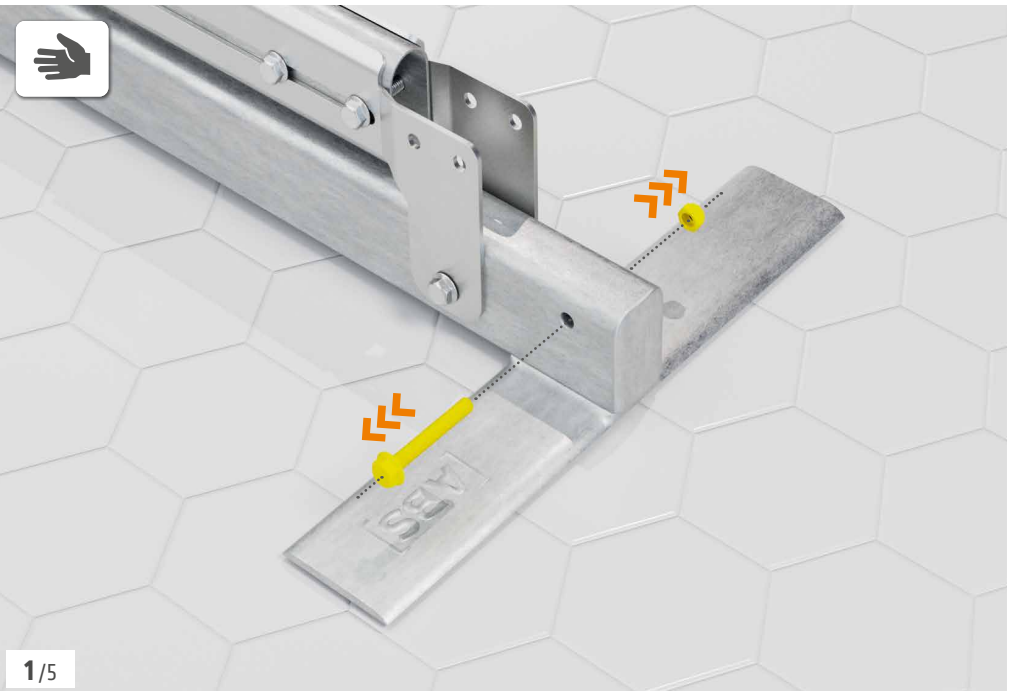
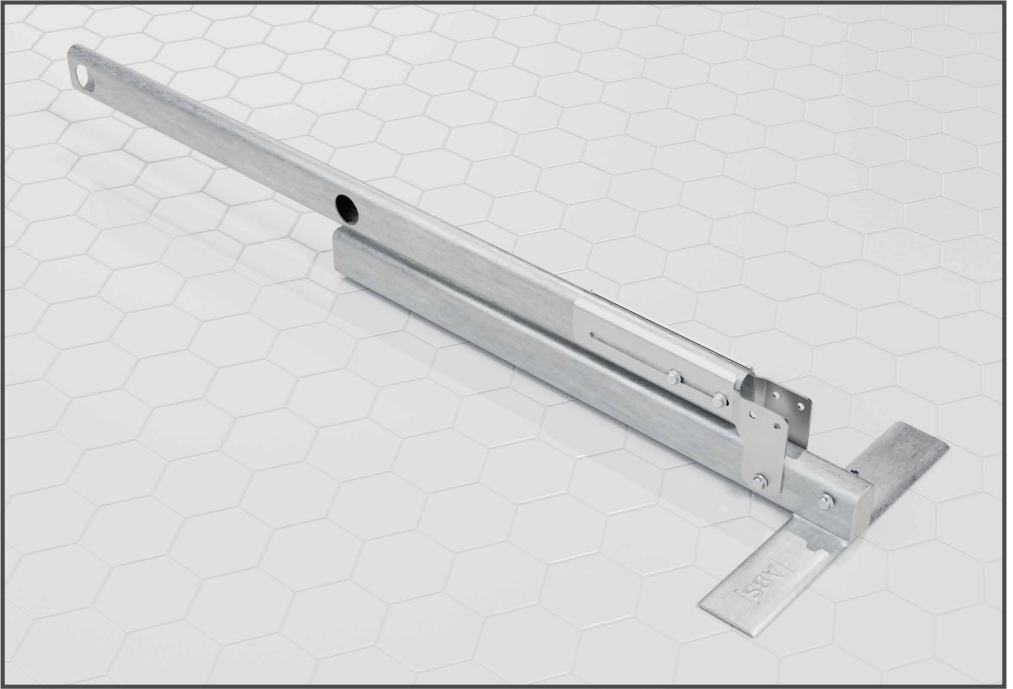







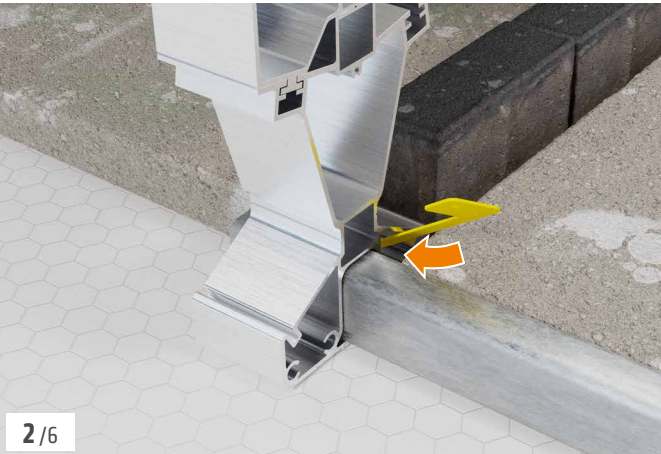

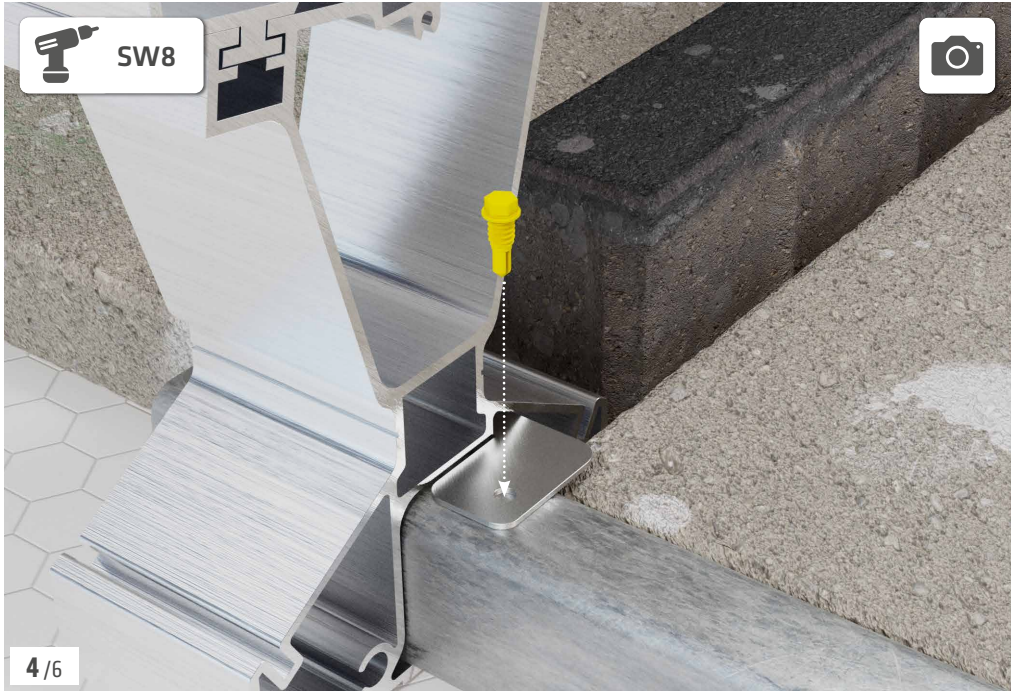

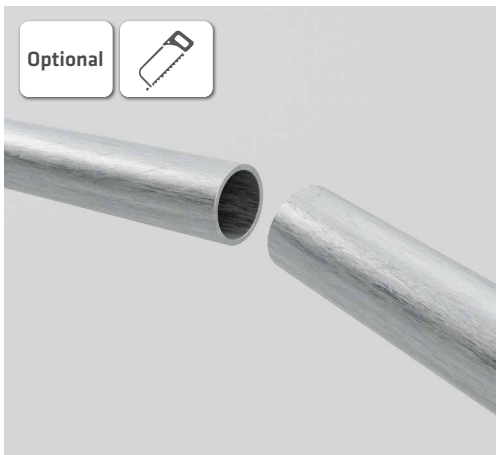
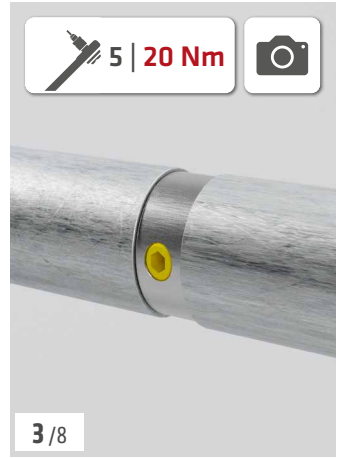
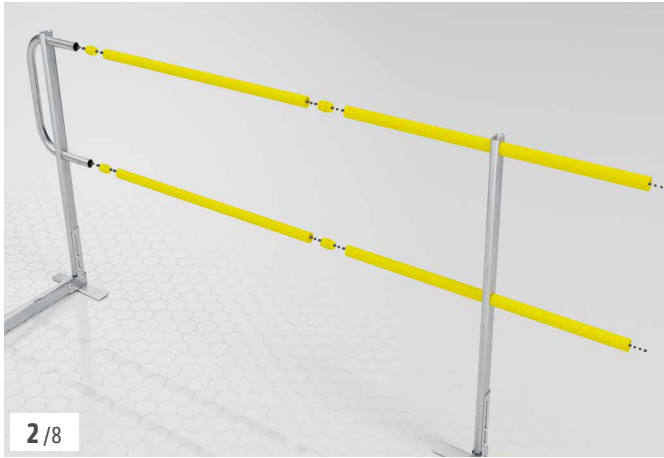
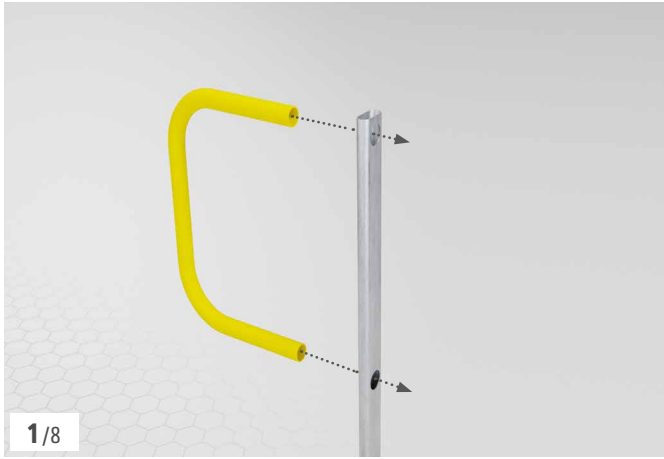

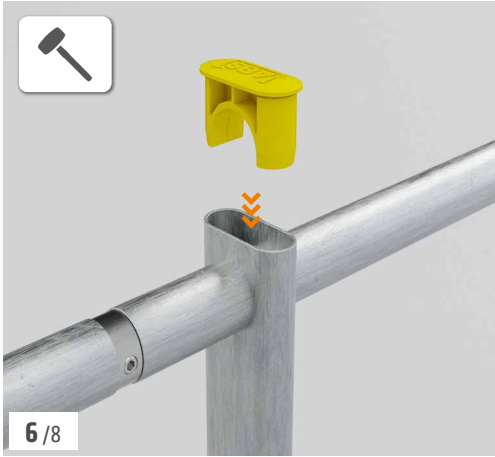

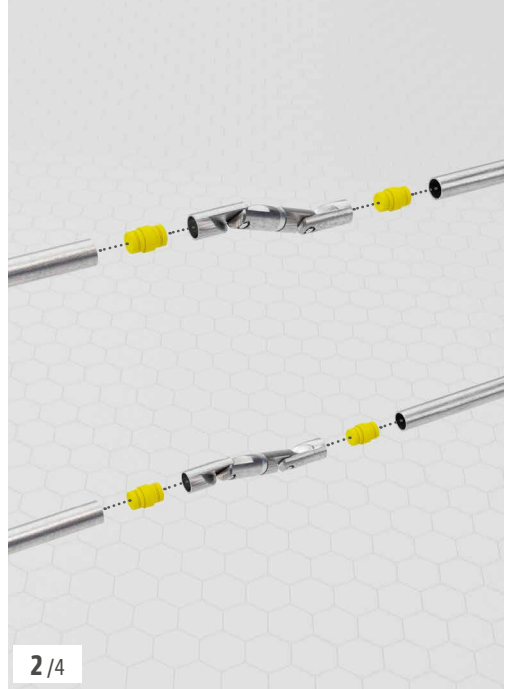
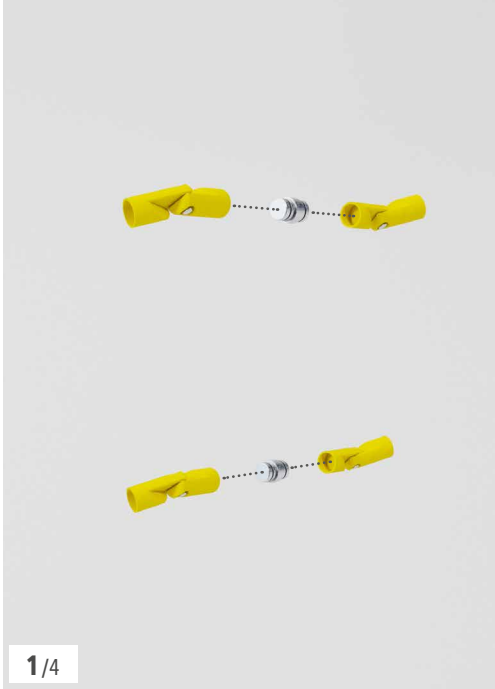

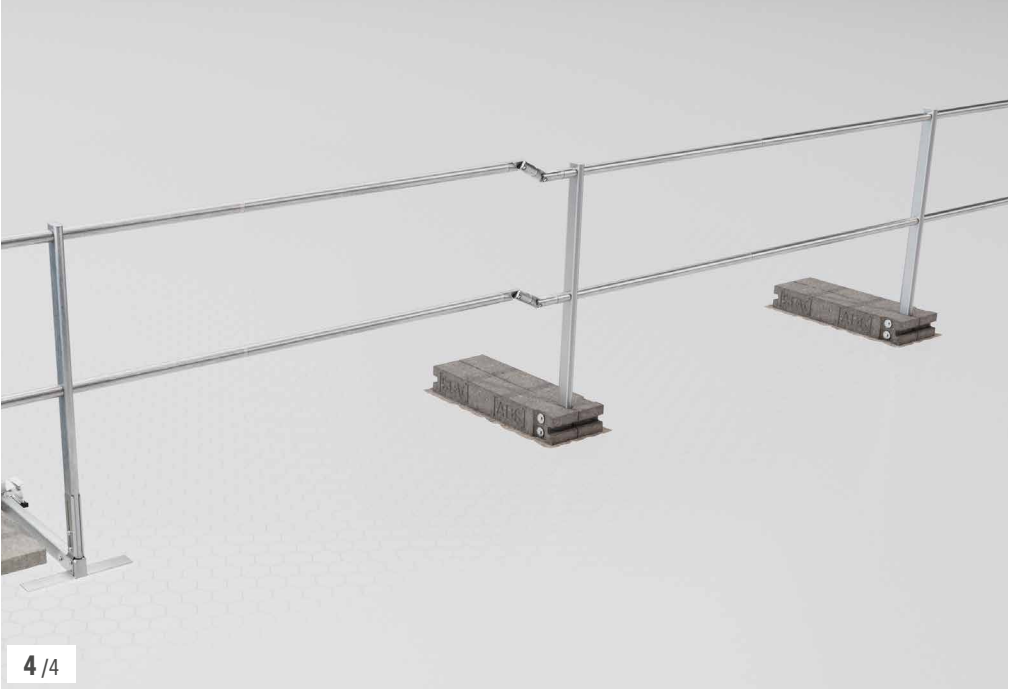

Optional



MoA 161
ABS Guard Toeboard

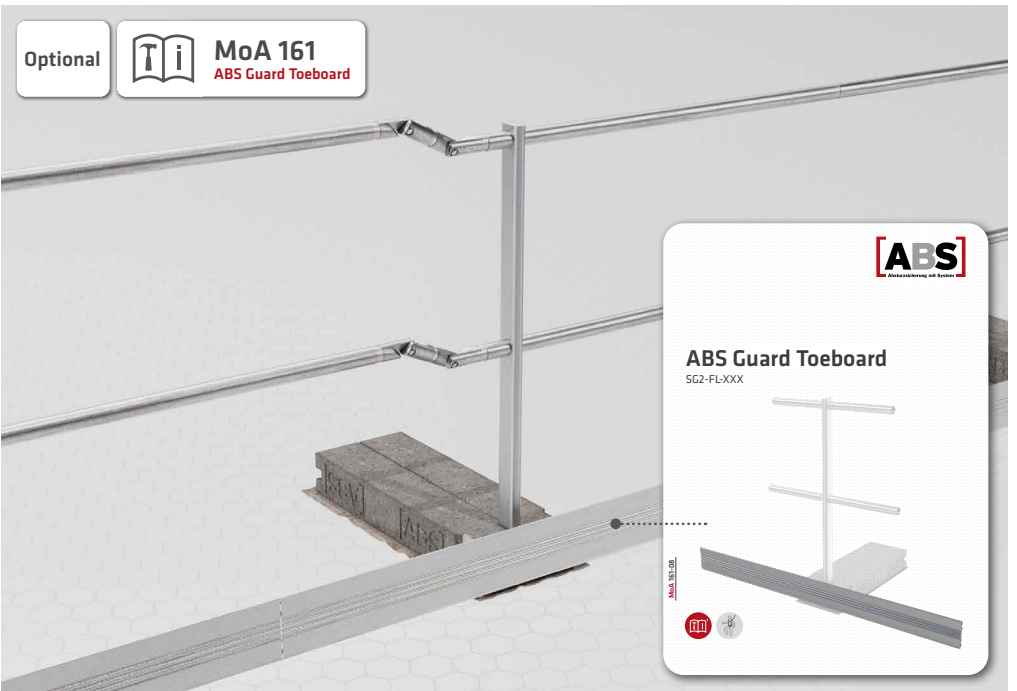

ABS Guard Toeboard
SG2-FL-XXX

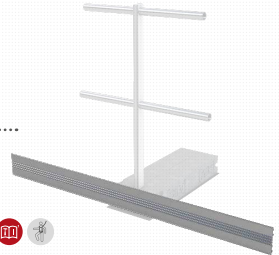

MoA 161-02







ALWAYS ON TOP!

ABS Safety GmbH

Gewerbering 3
D-47623 Kevelaer
Germany

Tel.: +49 28 32 972 81 - 0
Fax: +49 28 32 972 81 - 285

info@absturzschutz.de

 www.absturzschutz.de

 .de/en

 .de/fr

 .de/nl



[instagram.com/abssafety](https://www.instagram.com/abssafety)



[youtube.com/abssafetygmbh](https://www.youtube.com/abssafetygmbh)



[facebook.com/ABS.Safety](https://www.facebook.com/ABS.Safety)



[linkedin.com/company/abs-safety-gmbh](https://www.linkedin.com/company/abs-safety-gmbh)



[xing.com/pages/abssafetygmbh](https://www.xing.com/pages/abssafetygmbh)